

Interactive Visualization of Line Congruences for Spatial Mechanism Design

Pierre M. Larochelle

Robotics & Spatial Systems Lab Mechanical & Aerospace Engineering Department, Florida Institute of Technology, Melbourne, FL

Judy M. Vance

Virtual Reality Applications Center, Department of Mechanical Engineering, Iowa State University, Ames, Iowa

John N. Kihonge

Virtual Reality Applications Center, Department of Mechanical Engineering, Iowa State University, Ames, Iowa

This paper presents a framework for generating, representing, and interacting with the line congruences associated with four general finite poses. These line congruences are the solution space of spatial 4C mechanisms which will guide a moving body through the four prescribed poses. Hence, the contributions of this paper are applicable to developing interactive tools for designing spatial 4C mechanisms for four pose motion generation. Moreover, the strategies employed to address this difficult interactive visualization challenge are presented. The goal here being to facilitate future works which address other interactive visualization challenges. First, a methodology for generating a parameterized representation of the line congruences is reviewed. This is followed by strategies for visually representing the line congruences which are appropriate for both workstation and immersive virtual reality computer graphics. Next, strategies and supporting algorithms for interacting with the line congruences to obtain solution mechanisms with fixed links or coupler links in desired regions of the workspace are presented. The result is an intuitive interactive visual design methodology for generating and interacting with the line congruences associated with four general finite spatial poses for spatial 4C mechanism design. It is our desire that this effort, albeit focused upon the challenge of creating computer-aided design environments for spatial 4C mechanisms, will facilitate as well as motivate other efforts to address the inherent visualization and interaction challenges in designing three dimensional mechanical systems. [DOI: 10.1115/1.1529211]

Contributed by the Engineering, Simulation, and Visualization Committee for publication in the JOURNAL OF COMPUTING AND INFORMATION SCIENCE IN ENGINEERING. Manuscript received Jun. 2001; Revised Oct. 2002. Associate Editor: N. Patrikalakis.

1 Introduction

Mechanisms are often employed to move a body through a desired sequence of locations. To date, most commonly used mechanisms are planar in nature—they move a body such that the body is constrained to a plane. In order to generate general three-dimensional motion two common strategies are prevalent in practice: (1) utilize a sequence of planar mechanisms, (2) utilize a traditional robotic manipulator system. A sequence of planar mechanisms often results in a large device and it requires one or more actuators for each mechanism. Traditional robotic mechanical systems consist of links that are serially connected by joints; and each joint requires an actuator. A typical industrial robot has six or more actuators and a complex control system to coordinate the motion of these axes. Spatial mechanisms hold promise as an effective alternative. Spatial mechanisms are capable of moving a body in unconstrained three-dimensional space utilizing only one or two actuators. However, to date they are rarely implemented in great part due to the inherent visualization challenges involved in their design. This paper presents a methodology for addressing these visualization challenges.

The purpose of this paper is to present a framework for visually representing and interacting with the line congruences associated with four spatial poses or locations. These line congruences are the result of the spatial generalization of the center point and circle point curves of planar kinematics; consequently they are the set of lines that define the axes of *CC* dyads that guide a rigid body through four prescribed locations in space.^{1,2} Two *CC* dyads compatible with the four prescribed locations can then be connected in parallel to form a simple closed kinematic chain which is referred to as a spatial 4C mechanism. The resulting mechanism possesses two degrees of freedom and can be seen in Fig. 1.

In order to synthesize a spatial 4C mechanism to guide a body through four prescribed locations a designer may: (1) generate the fixed and moving congruences associated with the four locations; and subsequently, (2) select two lines from the congruences to define a 4C mechanism which is compatible with the four prescribed locations. We compute the congruences by employing the spatial triangle based technique presented by Larochelle [1], Murray and McCarthy [2], and McCarthy [3]. The result is a two dimensional parameterized set of lines. Our first utilization of this congruence generation technique resulted in the compute engine that powered the spatial 4C mechanism synthesis and analysis design software S_{PADES} , see Larochelle [4]. S_{PADES} successfully deployed the state of the art in spatial mechanism kinematic synthesis and analysis techniques on a traditional computer graphics workstation based platform. Though users have found S_{PADES} useful for designing mechanisms they have stated that one of the major challenges to designing spatial mechanisms for four desired locations is visualizing and interacting with the line congruences. This work focuses upon techniques for interactive visualization of

¹A cylindrical (*C*) joint is a two degree of freedom lower pair joint which allows translation along and rotation about a line in space. Moreover, a *CC* dyad consists of a rigid link that is connected to ground via one *C* joint and connected to the moving body or workpiece via a second *C* joint.

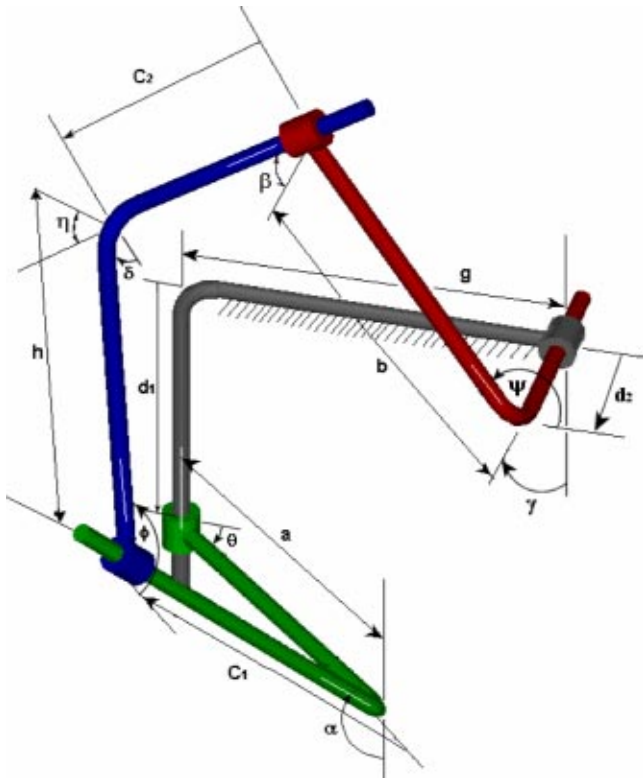

Fig. 1 A spatial 4C mechanism

the congruences to synthesize spatial 4C mechanisms for four location motion generation via the selection of *CC* dyads from the line congruences.

Our goal is to derive novel techniques for visually representing and interacting with the congruences to select *CC* dyads compatible with the four desired locations that possess desired properties such as axis location in the design space. These techniques are suited for both traditional workstation based computer graphics as well as immersive virtual reality environments such as the C6 and C2 facilities at Iowa State University. We hope that these techniques will in turn facilitate the creation of the next generation of computer-aided mechanism design software for spatial motion generation.

2 Congruence Generation

Before proceeding to the interactive visualization of the congruences it is instructive to review the congruence generation technique of Larochelle [1]. First, we review the spatial triangle technique of Murray and McCarthy [2]. This is followed by a methodology for utilizing the spatial triangle to generate the fixed and moving line congruences. Finally, techniques for completing a dyad once one line has been selected from a congruence is presented.

2.1 The Spatial Triangle. Let S_{12} and S_{23} be the finite relative screw axes associated with the spatial displacement from location 1 to location 2 and from location 2 to location 3 respectively. In Murray and McCarthy [2] it is shown that the spatial triangle prescribed by the finite screw axes S_{23} and S_{12} with internal dual angles $\Delta\hat{\phi}/2$ and $\Delta\hat{\theta}/2$ defines the coordinates of a fixed line G of a *CC* dyad compatible with four spatial locations, see Fig. 2. The dual vector equation of the spatial triangle may be written as,

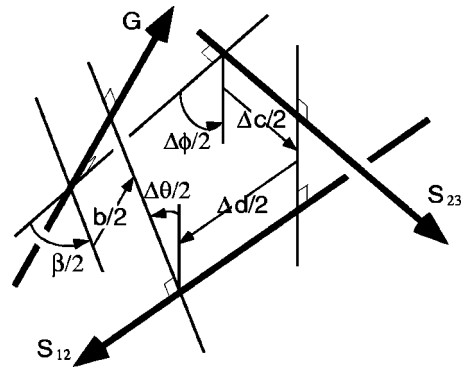

Fig. 2 The spatial triangle

$$\sin \frac{\hat{\beta}}{2} G = \sin \frac{\Delta \hat{\theta}}{2} \cos \frac{\Delta \hat{\phi}}{2} S_{12} + \cos \frac{\Delta \hat{\theta}}{2} \sin \frac{\Delta \hat{\phi}}{2} S_{23} + \sin \frac{\Delta \hat{\theta}}{2} \sin \frac{\Delta \hat{\phi}}{2} S_{12} \times S_{23} \quad (1)$$

$$\cos \frac{\hat{\beta}}{2} = \cos \frac{\Delta \hat{\theta}}{2} \cos \frac{\Delta \hat{\phi}}{2} + \sin \frac{\Delta \hat{\theta}}{2} \sin \frac{\Delta \hat{\phi}}{2} S_{12} \cdot S_{23} \quad (2)$$

In order to solve Eq. (1) and Eq. (2) for the desired line G the relationships between the spatial triangle, the complementary screw quadrilateral, and the 4C mechanism corresponding to the complementary screw quadrilateral must be maintained. We review those relationships here and outline the procedure for determining the line G given four spatial locations.

The generalization of Burmester's planar four location theory to four spatial displacements leads us to consider the complementary screw quadrilateral $S_{12}S_{23}S_{34}S_{14}$, where S_{12} , S_{13} , S_{14} , S_{23} , S_{24} , and S_{34} are the six relative finite screw axes associated with the four prescribed spatial locations, see Roth [5,6] and Bottema and Roth [7]. McCarthy [8] shows that by using the lines which define the complementary screw quadrilateral to define the axes of a spatial 4C mechanism one may obtain the fixed axis congruence in a parameterized form,² see Fig. 3. The procedure uses the lines which define the complementary screw quadrilateral to define a

²A planar version of this result that yields a parameterized form of the center point curve for four planar locations is found in McCarthy [9].

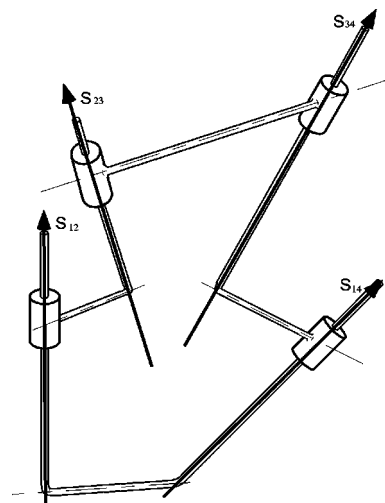

Fig. 3 The parameterizing spatial 4C mechanism

spatial 4C mechanism and identifying the quadrilateral as the *home* configuration of the parameterizing 4C mechanism. This results in a 4C mechanism with input link defined by the lines $S_{12}S_{23}$, fixed link defined by the lines $S_{12}S_{14}$ and coupler defined by the lines $S_{23}S_{34}$. We define the input angle $\hat{\theta}_0$ as the dual angle of the input link in the home configuration and similarly define the coupler angle $\hat{\phi}_0$ as the dual angle between the coupler and the input link in the home configuration. The screw axis of the displacement of the coupler of the parameterizing 4C mechanism from its home configuration to any other valid assembly is a fixed axis compatible with the given four general spatial locations. Hence, we obtain fixed axes that are parameterized by the input angle $\hat{\theta}$ of the parameterizing linkage.

Solving the spatial triangle associated with the two lines which define the input link in its home configuration, Eq. (1) and Eq. (2), results in the relative screw axis of the displacement of the coupler of the parameterizing 4C mechanism, where $\Delta\hat{\theta}=\hat{\theta}-\hat{\theta}_0$ and $\Delta\hat{\phi}=\hat{\phi}-\hat{\phi}_0$. Therefore, by solving the spatial triangle we obtain a fixed axis compatible with the given four general spatial locations which is parameterized by the input angle of the parameterizing 4C linkage. Note that the internal angles of the spatial triangle are given in terms of the relative input and coupler angles of the parameterizing 4C linkage with respect to its home configuration.

3 The Fixed Congruence

We now present a method of obtaining a numerical representation of the fixed congruence which is parameterized by the input angle of the parameterizing 4C linkage using the spatial triangle. Recall that the fixed congruence is a two dimensional set of lines that define the fixed axes that are compatible with four spatial locations and that a solution of the spatial triangle yields one line of the fixed congruence. Bottema and Roth [7] and Roth [10] have shown that the direction of each line G determines a unique plane and that all of the lines in that plane that are parallel to G are members of the fixed congruence. Hence, each line G defines a unique direction and corresponding to this direction there is an infinite set of compatible fixed lines of CC dyads.

We proceed with a method for using the spatial triangle to determine another line of the congruence, G_2 , which is parallel to $G_1=G$. These two lines then define the plane associated with G_1 . By examining Eq. (1) we see that the direction of G_1 is independent of the translation along, and the location of, the axes of the parameterizing 4C mechanism. In other words, the direction of G_1 is solely dependent upon the directions of the axes of the parameterizing linkage, this result was first presented by Roth [10]. Therefore, to obtain G_2 with the same direction as G_1 we maintain θ and vary our choice of d , where d is the translation of the input link of the parameterizing linkage along S_{12} , ($\hat{\theta}=\theta+\epsilon d$), and solve Eq. (1) and Eq. (2). Hence, for a given choice of parameter θ we select two different values of d which yield two lines G_1 and G_2 . These two lines then define a plane of the congruence and any line in this plane parallel to G is a member of the congruence.

We can now parameterize the lines in the plane associated with G that are members of the fixed congruence in terms of λ , where λ is the distance of the line from G . Given,

$$G(\theta)=G_1(\theta)=\begin{bmatrix} \mathbf{g} \\ \mathbf{g}_1^0 \end{bmatrix} \quad (3)$$

and,

$$G_2(\theta)=\begin{bmatrix} \mathbf{g} \\ \mathbf{g}_2^0 \end{bmatrix} \quad (4)$$

the lines $L_G(\theta,\lambda)$ that lie in the plane defined by G_1 and G_2 and are parallel to G may be expressed as,

$$L_G(\theta,\lambda)=\begin{bmatrix} \mathbf{g} \\ (\mathbf{p}_g+\lambda\mathbf{n})\times\mathbf{g} \end{bmatrix} \quad (5)$$

where,

$$\mathbf{n}=\frac{\mathbf{g}\times(\mathbf{g}_2^0-\mathbf{g}_1^0)}{\|\mathbf{g}\times(\mathbf{g}_2^0-\mathbf{g}_1^0)\|} \quad (6)$$

and,

$$\mathbf{p}_g=\mathbf{g}\times\mathbf{g}_1^0 \quad (7)$$

Note that \mathbf{n} is a unit vector in the direction of the common normal to the lines G_1 and G_2 , that \mathbf{p}_g is a point on G , and selecting $\lambda=0$ in Eq. (5) yields the line G . In Eq. (5) we have the two dimensional set of lines of the fixed congruence associated with four spatial locations parameterized by the angle θ of the input link of the parameterizing 4C mechanism (which selects a plane of the congruence) and a distance parameter λ (which selects a line in that plane).

Having reviewed the relationships between the relative screw axes, the complementary screw quadrilateral, the parameterizing 4C mechanism, and the spatial triangle, we now summarize the procedure for determining the fixed line congruence given four spatial locations.

1 From the four specified locations determine: the four relative screw axes (S_{12} , S_{23} , S_{34} , S_{14}), the link lengths of the corresponding parameterizing 4C linkage ($\hat{\alpha}=S_{12}\cdot S_{23}$, $\hat{\eta}=S_{23}\cdot S_{34}$, $\hat{\beta}=S_{14}\cdot S_{34}$, $\hat{\gamma}=S_{12}\cdot S_{14}$), and the angles $\hat{\theta}_0$ and $\hat{\phi}_0$.

2 Select the parameter value $\hat{\theta}$ and compute the corresponding $\hat{\phi}$ by performing a kinematic analysis of the parameterizing 4C linkage,³ see Larochelle [4].

3 Compute the internal angles of the spatial triangle, $\Delta\hat{\theta}$ and $\Delta\hat{\phi}$, and solve the two dual vector triangle equations, Eq. (1) and Eq. (2) for the unknown line $G_1(\theta)=G$.

4 For the same parameter value θ select a new value for d and compute the corresponding $\hat{\phi}$ by performing a kinematic analysis of the parameterizing 4C linkage.

5 Compute the internal angles of the spatial triangle, $\Delta\hat{\theta}$ and $\Delta\hat{\phi}$, and solve the two dual vector triangle equations, Eq. (1) and Eq. (2) for the unknown line $G_2(\theta)=G$.

6 If $\theta < 4\pi$ then increment θ and go to step 2 else done.

4 The Moving Congruence

The moving congruence is the two dimensional set of lines that define the moving lines of the CC dyads that are compatible with four spatial locations of a rigid body. We obtain a parameterized representation of the moving congruence by inverting the relationship between the fixed and moving coordinate frames and proceeding in an analogous manner to the generation of the fixed congruence. The inverted locations yield the relative screw axes S'_{12} , S'_{13} , S'_{14} , S'_{23} , S'_{24} . We then form a complementary screw quadrilateral, its corresponding parameterizing 4C mechanism, and solve the spatial triangle for a given choice of θ to obtain the lines $H=H_1$ and H_2 which define a plane of the moving congruence. Proceeding as we did in the generation of the fixed congruence we obtain the lines of the moving congruence associated with the parameter θ ,

$$L_H(\theta,\mu)=\begin{bmatrix} \mathbf{h} \\ (\mathbf{p}_h+\mu\mathbf{n})\times\mathbf{h} \end{bmatrix} \quad (8)$$

where,

$$\mathbf{n}=\frac{\mathbf{h}\times(\mathbf{h}_2^0-\mathbf{h}_1^0)}{\|\mathbf{h}\times(\mathbf{h}_2^0-\mathbf{h}_1^0)\|} \quad (9)$$

³In general for each θ there are two solutions for ϕ ; simply let θ vary from 0 to 4π and use the first solution for $0\leq\theta<2\pi$ and the second solution for $2\pi\leq\theta<4\pi$.

and,

$$\mathbf{p}_h = \mathbf{h} \times \mathbf{h}_1^0 \quad (10)$$

Again we note that \mathbf{p}_h is a point on H and that selecting $\mu=0$ in Eq. (8) yields the line H . The result, Eq. (8), is a two dimensional set of lines, given with respect to the moving frame, associated with four spatial locations that are parameterized by the angle θ of the input link of the parameterizing 4C mechanism (which selects a plane of the moving congruence) and a distance parameter μ (which selects a line in that plane).

4.1 Fixed & Moving Line Correspondence. There is a one-to-one correspondence between lines of the fixed congruence and lines of the moving congruence. That is to say, selecting a line from the fixed congruence as the fixed axis of a CC dyad uniquely determines the corresponding moving axis, and vice versa, see Roth [10]. Hence, selecting a fixed and moving line from the congruences to specify a CC dyad involves two free parameters; θ and either λ or μ . Therefore, to uniquely determine a 4C mechanism from the congruences requires the selection of four free parameters; $(\theta_1, \lambda_1$ or $\mu_1)$ which define one dyad and $(\theta_2, \lambda_2$ or $\mu_2)$ which define the second dyad. See Larochelle [11] for an efficient means to obtain the unknown line of a spatial CC dyad corresponding to a choice of θ and either λ or μ .

5 Interactive Visualization

We now summarize previous efforts to visualize the line congruences associated with four finite locations. This is followed by a presentation of our recent results in visually representing and interacting with the line congruences to design spatial 4C mechanisms.

5.1 Previous Efforts. Once a numerical representation of the congruences has been generated the challenge in creating an efficient design environment lies in providing a means of visually representing and interacting with the congruences. The first known visual representation of the line congruences associated with four spatial locations may be found in Fig. 26 of Bottema and Roth [7]. In this work Bottema and Roth visually illustrate a portion of the cubic cone associated with the orientations of the four spatial locations and in a separate figure adjacent to this they illustrate a portion of one plane of the congruence associated with a direction S_{ik} from the cone, see Fig. 4. A representation such as this which decouples the direction from the moment of the line leads to difficulties in visualizing the relationship of the congruence to the physical workspace of the resulting spatial mechanism.

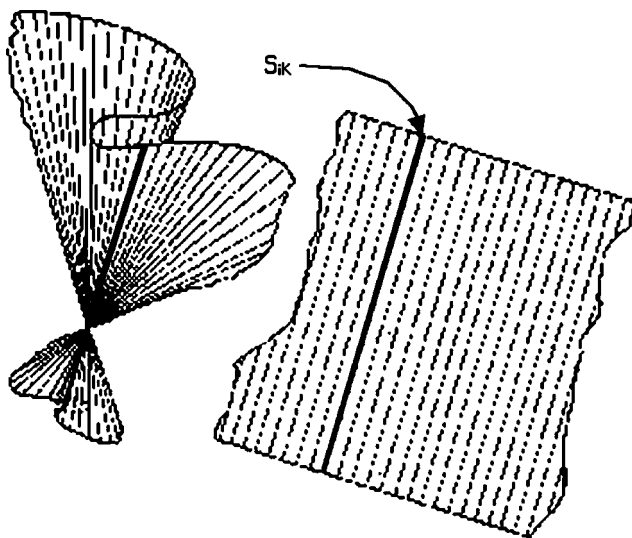

Fig. 4 Figure 26 from Bottema and Roth

However, it is important to note that in this work Bottema and Roth created a representation to explain the concept of the congruence; not for interactive design.

In 1991 Bodduluri [12] presented the first computer graphics generated representation of the line congruences for spatial 4C mechanism design (see Fig. 4 of his work). Bodduluri chose to represent the planes of the congruences by using two short parallel line segments. Upon close examination it is evident that identifying which two lines in the figure represent a given plane is difficult. Moreover, in his design environment Bodduluri restricts the designer to selecting lines from the displayed line segments. Obviously, this arbitrarily eliminates most of the solution space to the spatial motion generation problem at hand. Murray [13] presents a methodology for generating the congruences associated with four finite spatial locations. He elected to represent the congruences “by creating a pair of orthogonal lines for each plane generated in the congruence. The longer of the two lines corresponds to the direction of the lines in the plane.” Unfortunately, due to the projection of the two orthogonal lines which define each plane the viewer is unable to determine the orientation of each plane of the congruence.

In the works of Murray and McCarthy [2,14] the planes of the congruence associated with four spatial locations are represented by two dimensional wireframe rectangles whose shorter sides define the direction of the lines in the plane. In Murray and McCarthy [15] the planes of the fixed line congruence are represented again by these rectangles but in addition a line through the centroid of the rectangle in the direction associated with plane of the congruence is drawn. Note that by drawing a rectangle the orientation of the plane is now evident to the observer. However, two important criteria with regard to using the congruences for design are arbitrarily set: (1) the size of the rectangle, and, (2) the rectangle is chosen as the portion of the plane nearest the origin of the coordinate frame.

In Larochelle [1,4] an attempt was made at generating and representing the congruences for spatial mechanism design. The previous attempts at visually representing the congruences were combined into a new solid model representation of the congruences. The planes of the congruences were represented by rectangular parallelepiped solids whose major axes were displayed and they defined the direction of the lines associated with each plane; see Fig. 5. The addition of the solid models enhance the three-dimensional depth perception of the visualization and facilitated the design process. However, the arbitrary selection of the portion of the infinite planes represented as well as the difficulty in visualizing the relationship between the congruences and the physical workspace continued to make designing useful mechanisms a challenge.

5.2 Current Efforts. All previous visual representations of the congruences fail to address the following visualization challenge: How to visually represent the information contained in an infinite number of infinite planes in a manner that is useful for mechanism design? In other words, how to present to the designer a visual representation of the infinite number of axis directions available as well as the infinite number of lines associated with each direction? Moreover, it is essential that the information be presented to the designer in such a manner that the relative locations of the lines to the physical workspace of the mechanism is obvious. This is because the mechanism designer seeks a solution 4C mechanism which has links in some finite region of the physical workspace. Here we present methodologies for visually representing and interacting with the congruences that are appropriate in both a traditional computer workstation environment and in an immersive virtual environment.

In 2001 Kihonge, Larochelle and Vance [16] generated the first virtual reality based representation of the congruences associated with four spatial locations. The purpose of this first step was to explore the utility of virtual reality as a visualization tool for congruence representation. The rectangular solid approach of

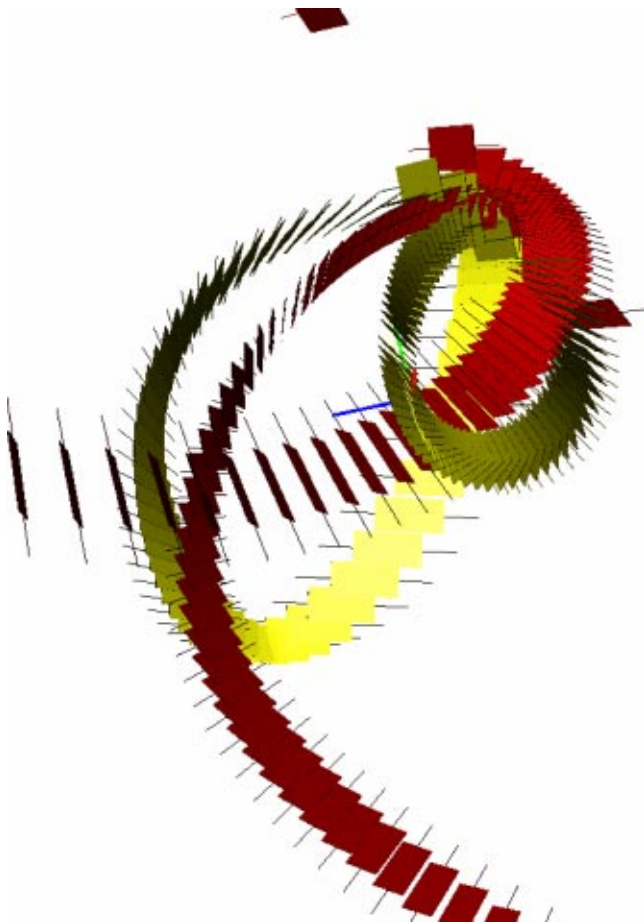

Fig. 5 Figure 5 from Larochelle [4]

Larochelle [4] was implemented into an immersive virtual reality based application, see Fig. 6 and Larochelle and Vance [17]. The immersive capabilities facilitated congruence visualization by the designer however the lack of connection to the actual physical workspace of the mechanism was a hindrance to generating useful mechanism designs. For example, selecting fixed axes from the congruences was facilitated by the virtual reality visualization and interaction tools however where those fixed axes were located with respect to the actual workspace of the mechanism was unknown to the designer. **Our new approach is to generate a three dimensional design space in which the designer can synthesize spatial mechanisms and obtain a sense of the form and function of the devices.** In order to realize this *design-in-context*⁴ approach the congruences must be generated and displayed with respect to geometric models of the physical design space. In our virtual reality program VRSpatial geometric models of the surrounding geometry are imported into a virtual environment and the congruences are displayed within this same virtual representation of the physical workspace.

The VRSpatial program was designed for display in Iowa State University's C2 facility, see Fig. 7. The C2 is a 12×12 foot room where stereo images are projected on three walls and the floor. Left and right eye images are displayed alternately on the screens. CrystalEyes shutter glasses are used to perceive images in three dimensions. The C2 has a three-dimensional sound system and 3D interaction capabilities. Two Silicon Graphics Power Onyx computers provide the computer capacity for the C2. For tracking purposes, one pair of glasses has a sensor on it and is tracked by

⁴The *design-in-context* approach was first applied to spherical mechanism design by Furlong, Vance, and Larochelle [18].



Fig. 6 2001 congruence visualization

an Ascension Flock of Birds magnetic tracker. The user's view and head orientation are used to compute the viewing perspective for display of images on the screens so that the four screens are perceived as a single environment. All the other users in the C2 will see the view of the person wearing the tracked glasses.

The C2 environment works well where collaboration with other users in a virtual environment is desired. Multiple users can be present in the C2 facility at the same time. Figure 11 shows two users in the C2 during the design of a spatial 4C mechanism. Because all users wear simple stereo glasses, participants can see both the stereo images and the other people in the C2 environ-

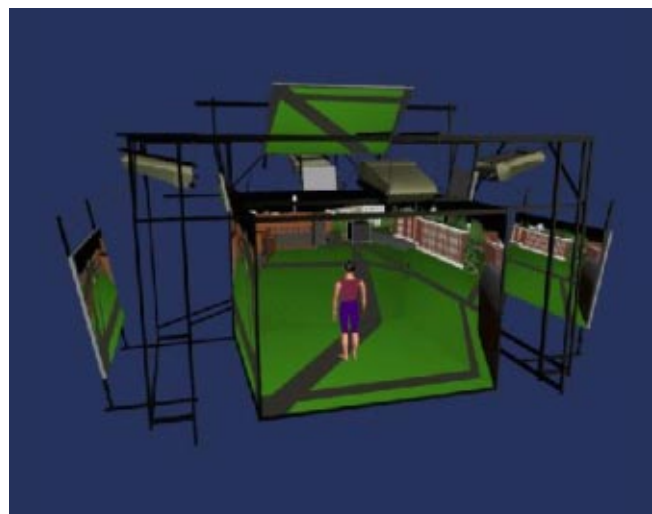

Fig. 7 ISU C2 immersive facility

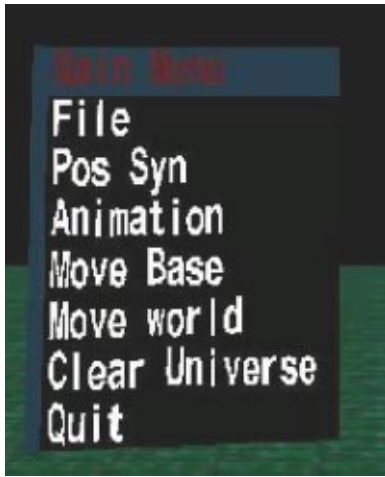

Fig. 8 VRSpatial: main menu

ment. This allows for easy interaction among users and fosters collaboration within the VR environment. In VRSpatial, interaction is performed using a Fakespace PINCH Glove. The PINCH Glove has conductive material placed on the finger tips, thumb and palm of the glove to register contact between a user's fingers, palm and thumb. Gestures are used to control actions in the virtual environment. Because a person's real hand sometimes obstructs the virtual objects, a digital hand model is used in the environment to correspond to the location of the participant's hand in space.

The software platform for VRSpatial is WorldToolKit. Menus are used to provide more options for interaction with the VR environment. The menus are 3D objects consisting of a menu bar and text items, see Fig. 8. The main menu can be opened at any time during the design process by contacting the little finger and the thumb. A menu can be repositioned in space by intersecting the virtual hand model with the menu bar and grasping the menu bar using the first finger and the thumb. This allows the user to move the menu to a location in the virtual environment that is convenient. A menu option is selected by intersecting the virtual hand model with the menu option and then making a gesture of touching the second finger to the thumb. These menus are used to control the tasks in the virtual environment.

To define the mechanism design problem, first, models of objects that will be in the vicinity of the final mechanism are loaded

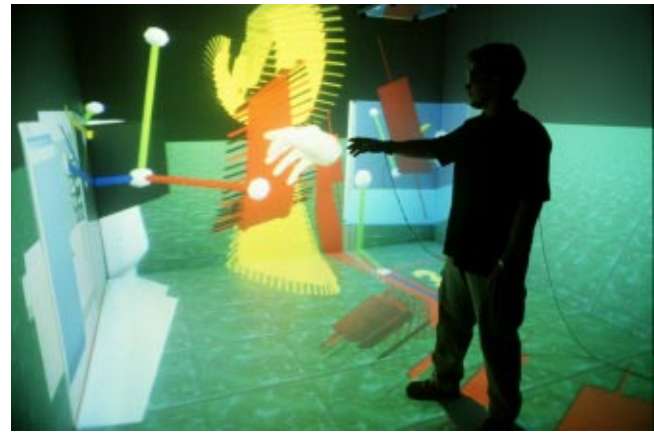

Fig. 10 VRSpatial: congruences

into the environment. These could be machine tools, other parts on an adjacent product, assembly fixtures, etc. Then, the part that is to be moved by the mechanism is loaded. Once this part is placed in a desired location, another instance of the part is generated and the user places this part in the next location. This continues until four representations of the part that is to be moved by the mechanism have been located. The locations can be modified and then numbered 1, 2, 3 and 4 to indicate the order of the movement, see Fig. 9. In this example a lathe and a table were loaded as the base geometry. The design task was to design a mechanism that would move a workpiece from the lathe to the table. Figure 9 shows a designer in the virtual environment with the virtual representations of the lathe and table.

The fixed and moving line congruences associated with the four locations are computed and are represented as sets of planes in the virtual environment with a single central line. The moving congruences are represented by yellow planes and the fixed congruences are represented by red planes, see Fig. 10. The user then has to select two lines from the congruences to completely define a solution mechanism. When a choice is made from the congruences, the axis of the chosen plane turns blue. A dyad is picked from the moving plane congruences and another from the fixed plane congruences to define a complete spatial 4C mechanism.

After a mechanism has been chosen from the congruences it is animated to verify it completes the task as required in an accept-



Fig. 9 VRSpatial: defining four locations

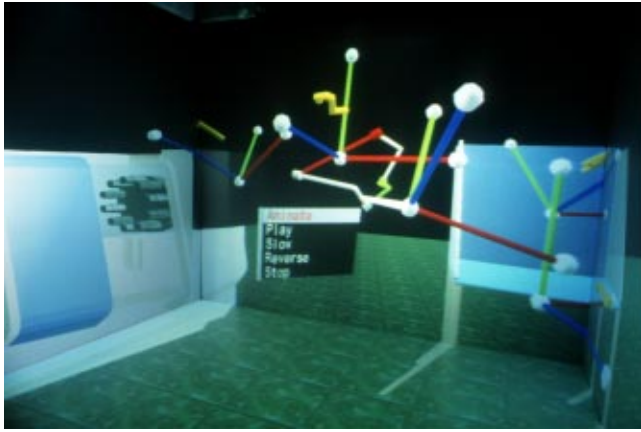

Fig. 11 VRSpatial: 4C mechanism display

able manner, see Fig. 11. The animation utilizes a linear interpolation of the values of θ and d_1 that place the moving body in each of the 4 desired locations. To successfully complete the task the mechanism should not only move the object through the four locations but it must also interface with the workspace in an acceptable manner. The user can observe the motion of the mechanism to see whether the mechanism collides with objects in the virtual space and whether it goes through the locations in the required order. The user with the tracked glasses can move around the design and investigate the mechanism from different angles.

6 Interaction Visualization Summary

Here we summarize what we have learned about using virtual reality techniques for the design of spatial 4C mechanisms. Most, if not all, of these lessons learned apply equally well to the design of all 3D mechanical systems.

The common practice of using coordinate frames to define the locations of bodies in traditional graphic representations is also desirable in a virtual environment. Though the natural instinct in a virtual environment is to represent all bodies with solid geometric models, the designer benefits from having the ability to interact with either the geometric model itself or a coordinate frame. This may be due to the current features present in the user interface technologies available in virtual environments. Future high bandwidth haptic interfaces with force feedback may provide the designer with sufficient “feel” for the solid models that coordinate frames would no longer be useful.

The evaluation of a candidate design requires a careful examination of the entire motion cycle of the mechanism. For example, when evaluating a candidate solution for a planar four-bar mechanism designed to achieve four finite positions, the designer knows that the motion of all parts of the mechanism is confined to the plane and that all of the links at all times will remain inside a bounded rectangular region of the plane (this region has no side longer than the sum of the two longest link lengths). This is not the case with spatial mechanisms. When evaluating a candidate solution for a spherical four-bar mechanism designed to achieve four finite orientations, the designer knows that the motion of all parts is confined to the surface of a sphere and that the radius of the sphere is a free design variable. However, for the design of spatial mechanisms, the design space is truly spatial and in nature with no obvious bounds. For example, consider a non-Grashof spatial 4C mechanism with all link lengths equal to unity. In four different configurations one or more C joint translations will approach infinity (Larochelle [19]). Moreover, the motion is not confined to a plane or a sphere. The moving body can and does move in non-intuitive fashions and this necessitates a careful evaluation of the entire motion cycle. The virtual reality representation of the mechanism facilitates this evaluation.

The use of a well-developed virtual environment greatly facilitates the evaluation of candidate designs to secondary design criteria. These criteria often include: interference avoidance, collision avoidance, aesthetics, and ergonomics. The ability to walk around the solution space and “peer into” constrained spaces gives the designer a three-dimensional view of the mechanism and how the motion relates to other objects in the design space.

It is important to avoid providing the designer with too much visual information. It is easy to create a virtual environment that provides a very interactive and detailed virtual environment in which to work with highly texture mapped surroundings. However, our experience has been that focused presentation of information, as requested by the designer, is the most efficient. We have found that by letting the designer request detailed information when it is needed the designer feels most comfortable working in a virtual representation of the design workspace.

7 Conclusion

In this paper we have presented procedures for visually representing and interacting with the fixed and moving line congruences associated with four finitely separated spatial locations or poses. Both traditional computer-graphics workstations and virtual reality immersive environments were discussed and utilized to address the visualization challenges. It is hoped that this effort focused upon the challenge of creating computer-aided design environments for spatial 4C mechanisms will facilitate and motivate other efforts to address the inherent visualization and interaction challenges in designing three dimensional mechanical systems.

Acknowledgments

The support of the U.S. National Science Foundation, grants DMI-9816611 and DMI-9872604, is gratefully acknowledged.

References

- [1] Larochelle, P., 1995, “On the Design of Spatial 4C Mechanisms for Rigid-Body Guidance Through 4 Positions,” *Proceedings of the 1995 ASME Design Engineering Technical Conferences*, vDE-82, pp.825-832, Sept. 1995, Boston, Massachusetts.
- [2] Murray, A. P., and McCarthy, J. M., 1994, “Five Position Synthesis of Spatial CC Dyads,” *Proceedings of the 1994 ASME Design Technical Conferences*, DE-v70, pp.143-152, September, 1994, Minneapolis, Minnesota.
- [3] McCarthy, J. M., 2000, *Geometric Design of Linkages*. Springer-Verlag.
- [4] Larochelle, P., 1998, “SPADES-Software for Synthesizing Spatial 4C Mechanisms,” Winner of the MDI Mechanical Simulation Software Award. *Proceedings of the 1998 ASME Design Engineering Technical Conferences*. Sept. 1998, Atlanta, Georgia.
- [5] Roth, B., 1967, “The Kinematics of Motion Through Finitely Separated Positions,” *J. Appl. Mech.*, **34**, pp. 591–599, September.
- [6] Roth, B., 1967, “Finite-Position Theory Applied to Mechanism Synthesis,” *J. Appl. Mech.*, **34**, pp. 599–605, September.
- [7] Bottema, O., and Roth, B., 1979, *Theoretical Kinematics*, North-Holland, Amsterdam.
- [8] McCarthy, J. M., 1993, “A Parameterization of the Central Axis Congruence Associated with Four Positions of a Rigid Body,” *ASME J. Mech. Des.*, **115**, pp. 547–551, Sept.
- [9] McCarthy, J. M., 1993, “The Opposite Pole Quadrilateral as a Compatibility Linkage for Parameterizing the Center Point Curve,” *ASME J. Mech. Des.*, **115**, pp. 332–336, June.
- [10] Roth, B., 1967, “On the Screw Axes and Other Special Lines Associated with Spatial Displacements of a Rigid Body,” *J. Eng. Ind.*, pp. 102–110, February.
- [11] Larochelle, P., 1994, “Design of Cooperating Robots and Spatial Mechanisms,” Ph.D. Dissertation, University of California, Irvine.
- [12] Bodduluri, R. M. C., 1991, “Interactive Graphics for Four Position Synthesis of 4C Spatial Mechanisms,” *Proceedings of the 8th World Congress on the Theory of Machines and Mechanisms*. Aug. 1991, Prague, Czechoslovakia.
- [13] Murray, A. P., 1993, “The Central Axis and Circling Axis Congruences as Projections of the Constraint Manifold of the Complementary Screw Quadrilateral,” M.S. Thesis, University of California, Irvine.
- [14] Murray, A. P., and McCarthy, J. M., 1999, “Burmester Lines of Spatial Five Position Synthesis from the Analysis of a 3-CPC Platform,” *ASME J. Mech. Des.*, **121**, pp. 45–49, March.
- [15] Murray, A. P., and McCarthy, J. M., 1996, “Passing a Central Axis Congruence Through Six Arbitrary Lines in space,” *ASME J. Mech. Des.*, **118**, pp. 515–519, Dec.
- [16] Kihonge, J., Vance, J., and Larochelle, P., 2001, “Spatial Mechanism Design in Virtual Reality with Networking,” *Proceedings of the ASME 2001 Interna-*

tional Design Engineering Technical Conferences. Sept. 2001, Pittsburgh, Pennsylvania.

- [17] Larochelle, P. M., and Vance, J. M., 2000, "Interactive Visualization of the Line Congruences Associated with Four Finite Spatial Poses," *Proceedings of the Symposium Commemorating the Legacy, Works, and Life of Sir Robert Stawell Ball*. University of Cambridge.
- [18] Furlong, T. J., Vance, J. M., and Larochelle, P. M., 1999, "Spherical Mechanism Synthesis in Virtual Reality," *ASME J. Mech. Des.*, **121**, pp. 515–520, Dec.
- [19] Larochelle, P., 2000, "Circuit and Branch Rectification of the Spatial 4C Mechanism," *Proceedings of the 2000 ASME Design Engineering Technical Conferences*. Sept. 2000, Baltimore, Maryland.